

High Performance Schottky Generation 5.0, 2 x 3 A

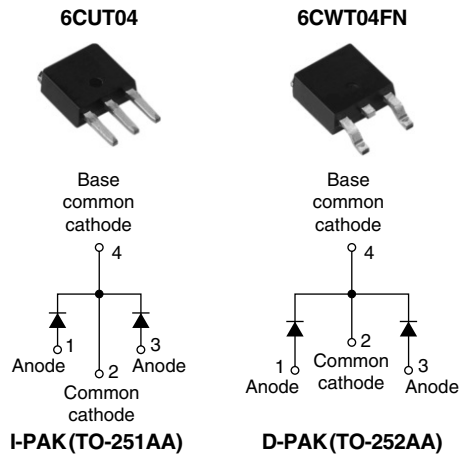

FEATURES

- 175 °C high performance Schottky diode
- Very low forward voltage drop
- Extremely low reverse leakage
- Optimized V_F vs. I_R trade off for high efficiency
- Increased ruggedness for reverse avalanche capability
- RBSOA available
- Negligible switching losses
- Submicron trench technology
- Fully lead (Pb)-free and RoHS compliant devices
- Qualified for AEC Q101

**RoHS
COMPLIANT**

APPLICATIONS

- Specific for PV cells bypass diode
- High efficiency SMPS
- Automotive
- High frequency switching
- Output rectification
- Reverse battery protection
- Freewheeling
- Dc-to-dc systems
- Increased power density systems

PRODUCT SUMMARY

$I_{F(AV)}$	2 x 3 A
V_{RRM}	45 V
Maximum V_F at 3 A at 125 °C	0.54 V

MAJOR RATINGS AND CHARACTERISTICS

SYMBOL	CHARACTERISTICS	VALUES	UNITS
V_{RRM}		45	V
V_F	3 Apk, $T_J = 125$ °C (typical, per leg)	0.46	V
T_J	Range	- 55 to 175	°C

VOLTAGE RATINGS

PARAMETER	SYMBOL	TEST CONDITIONS	6CUT04 6CWT04FN	UNITS
Maximum DC reverse voltage	V_R	$T_J = 25$ °C	45	V

ABSOLUTE MAXIMUM RATINGS					
PARAMETER	SYMBOL	TEST CONDITIONS		VALUES	UNITS
Maximum average forward current per leg per device	$I_{F(AV)}$	50 % duty cycle at $T_C = 166\text{ }^\circ\text{C}$, rectangular waveform		3	A
				6	
Maximum peak one cycle non-repetitive surge current per leg	I_{FSM}	5 μs sine or 3 μs rect. pulse	Following any rated load condition and with rated V_{RRM} applied	440	A
		10 ms sine or 6 ms rect. pulse		70	
Non-repetitive avalanche energy per leg	E_{AS}	$T_J = 25\text{ }^\circ\text{C}$, $I_{AS} = 1.3\text{ A}$, $L = 16\text{ mH}$		14	mJ
Repetitive avalanche current per leg	I_{AR}	Limited by frequency of operation and time pulse duration so that $T_J < T_J\text{ max.}$ I_{AS} at $T_J\text{ max.}$ as a function of time pulse (see fig. 8)		I_{AS} at $T_J\text{ max.}$	A

ELECTRICAL SPECIFICATIONS						
PARAMETER	SYMBOL	TEST CONDITIONS		TYP.	MAX.	UNITS
Forward voltage drop per leg	$V_{FM}^{(1)}$	3 A	$T_J = 25\text{ }^\circ\text{C}$	0.535	0.600	V
		6 A		0.615	0.680	
		3 A	$T_J = 125\text{ }^\circ\text{C}$	0.485	0.540	
		6 A		0.570	0.640	
Reverse leakage current per leg	$I_{RM}^{(1)}$	$T_J = 25\text{ }^\circ\text{C}$	$V_R = \text{Rated } V_R$	-	25	μA
		$T_J = 125\text{ }^\circ\text{C}$		-	3	mA
Junction capacitance per leg	C_T	$V_R = 5\text{ V}_{DC}$ (test signal range 100 kHz to 1 MHz), $25\text{ }^\circ\text{C}$		240	-	pF
Series inductance per leg	L_S	Measured lead to lead 5 mm from package body		8.0	-	nH
Maximum voltage rate of change	dV/dt	Rated V_R		-	10 000	V/ μs

Notes(1) Pulse width < 300 μs , duty cycle < 2 %

THERMAL - MECHANICAL SPECIFICATIONS					
PARAMETER	SYMBOL	TEST CONDITIONS		VALUES	UNITS
Maximum junction and storage temperature range	T_J, T_{Stg}			- 55 to 175	$^\circ\text{C}$
Maximum thermal resistance, junction to case per leg	R_{thJC}	DC operation		4.7	$^\circ\text{C/W}$
Maximum thermal resistance, junction to case per device				2.35	
Typical thermal resistance, case to heatsink	R_{thCS}			0.3	
Approximate weight				0.3	g
				0.01	oz.
Marking device		Case style I-PAK		6CUT04	
		Case style D-PAK		6CWT04FN	

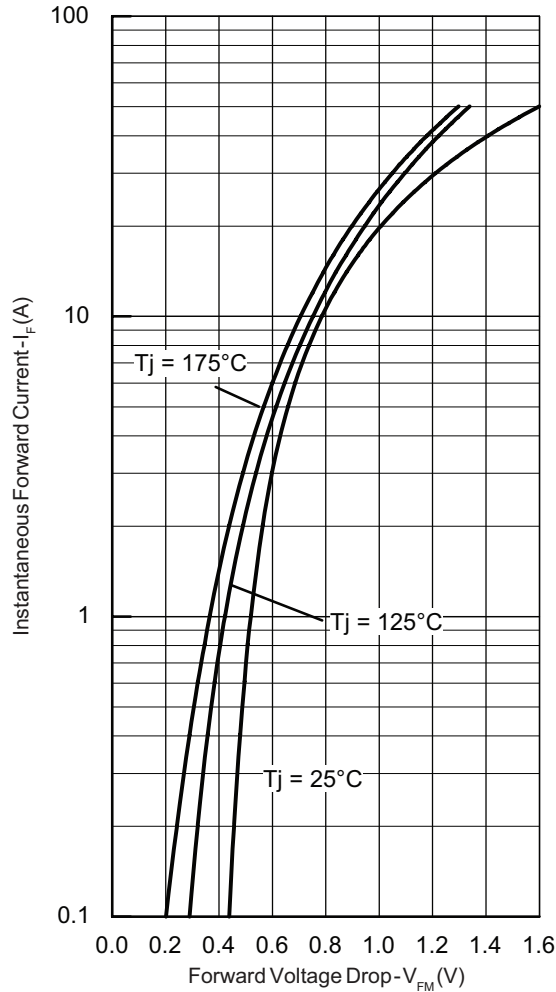

Fig. 1 - Maximum Forward Voltage Drop Characteristics

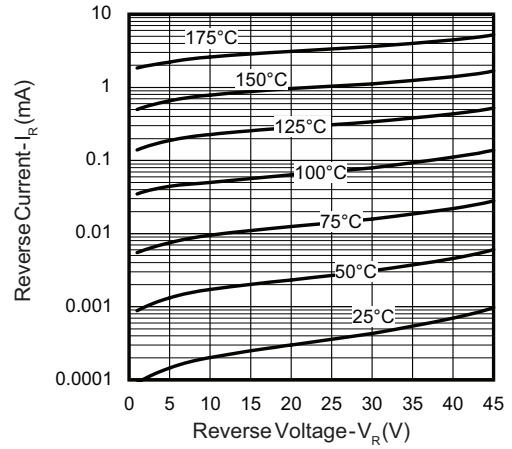

Fig. 2 - Typical Values of Reverse Current vs. Reverse Voltage

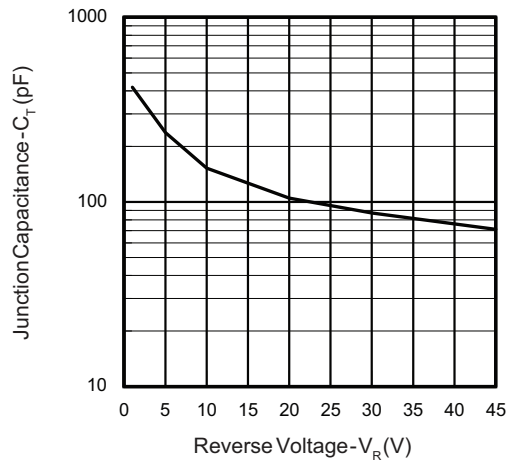

Fig. 3 - Typical Junction Capacitance vs. Reverse Voltage

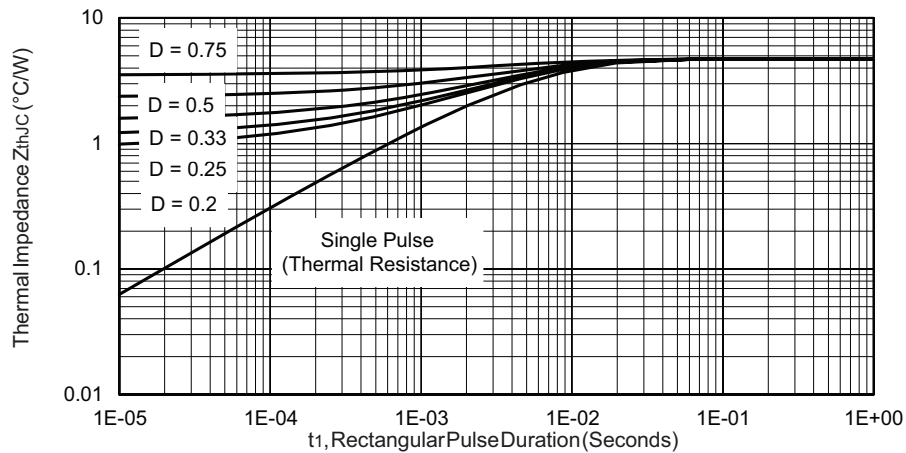

Fig. 4 - Maximum Thermal Impedance Z_{thJC} Characteristics

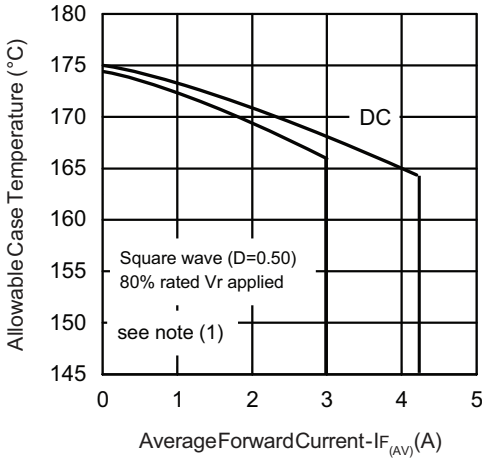

Fig. 5 - Maximum Allowable Case Temperature vs. Average Forward Current

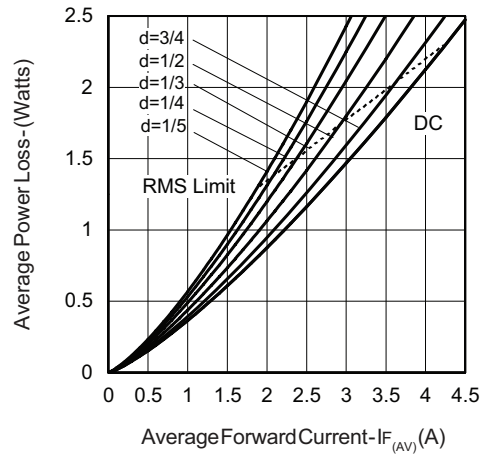

Fig. 6 - Forward Power Loss Characteristics

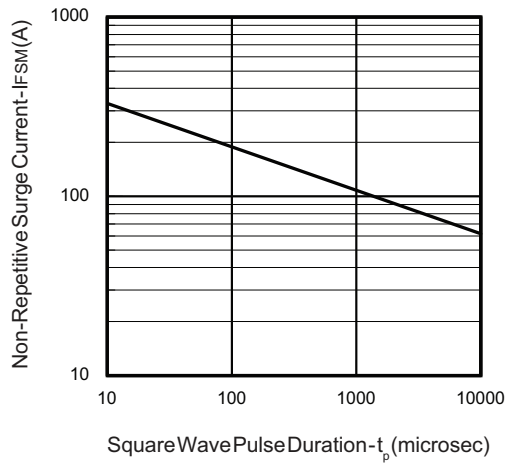

Fig. 7 - Maximum Non-Repetitive Surge Current

Note

- (1) Formula used: $T_C = T_J - (P_d + P_{d_{REV}}) \times R_{thJC}$;
 P_d = Forward power loss = $I_{F(AV)} \times V_{FM}$ at $(I_{F(AV)}/D)$ (see fig. 6);
 $P_{d_{REV}}$ = Inverse power loss = $V_{R1} \times I_R (1 - D)$; I_R at $V_{R1} = 80\%$ rated V_R

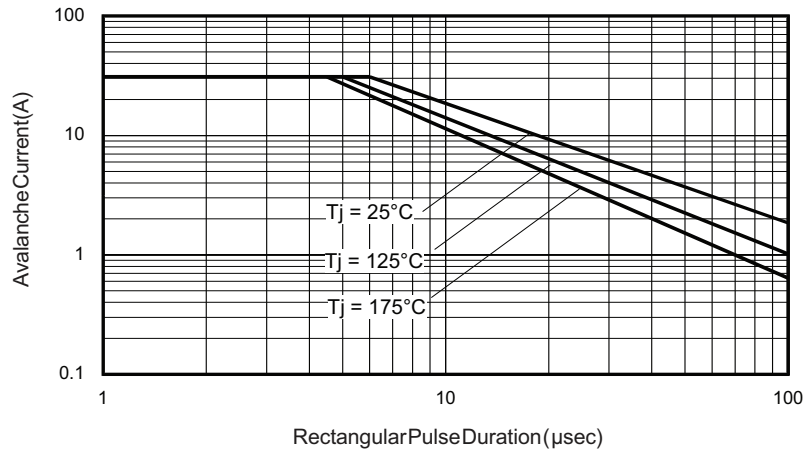

Fig. 8 - Reverse Bias Safe Operating Area (Avalanche Current vs. Rectangular Pulse Duration)

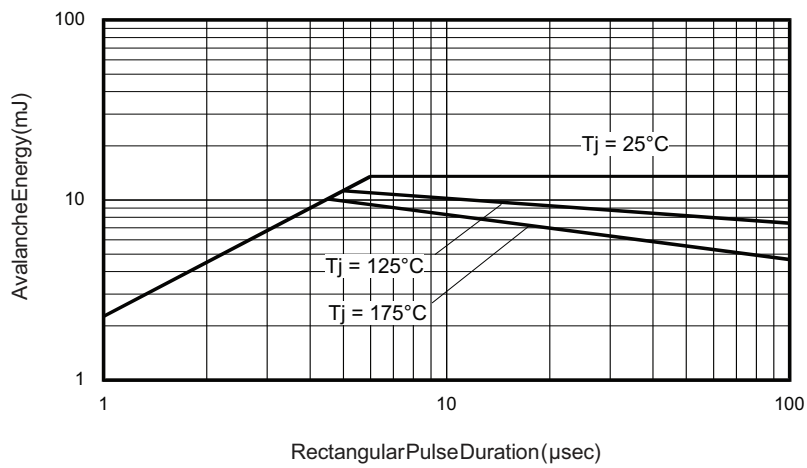

Fig. 9 - Reverse Bias Safe Operating Area (Avalanche Energy vs. Rectangular Pulse Duration)

6CUT04, 6CWT04FN

Vishay High Power Products

High Performance
Schottky Generation 5.0, 2 x 3 A



ORDERING INFORMATION TABLE

Device code	6	C	U	T	04	FN	TRL
	①	②	③	④	⑤	⑥	⑦

- 1** - Current rating (6 A)
- 2** - Circuit configuration:
 - C = Common cathode
- 3** - Package:
 - U = I-PAK
 - W = D-PAK
- 4** - T = Trench
- 5** - Voltage rating (04 = 45 V)
- 6** - TO-252AA (D-PAK)
- 7** - D-PAK, I-PAK: None = Tube (75 pieces)
D-PAK only:
 - TR = Tape and reel
 - TRL = Tape and reel (left oriented)
 - TRR = Tape and reel (right oriented)

LINKS TO RELATED DOCUMENTS	
Dimensions	http://www.vishay.com/doc?95024
Part marking information	http://www.vishay.com/doc?95025
Packaging information	http://www.vishay.com/doc?95033
SPICE model	http://www.vishay.com/doc?95038



Disclaimer

All product specifications and data are subject to change without notice.

Vishay Intertechnology, Inc., its affiliates, agents, and employees, and all persons acting on its or their behalf (collectively, "Vishay"), disclaim any and all liability for any errors, inaccuracies or incompleteness contained herein or in any other disclosure relating to any product.

Vishay disclaims any and all liability arising out of the use or application of any product described herein or of any information provided herein to the maximum extent permitted by law. The product specifications do not expand or otherwise modify Vishay's terms and conditions of purchase, including but not limited to the warranty expressed therein, which apply to these products.

No license, express or implied, by estoppel or otherwise, to any intellectual property rights is granted by this document or by any conduct of Vishay.

The products shown herein are not designed for use in medical, life-saving, or life-sustaining applications unless otherwise expressly indicated. Customers using or selling Vishay products not expressly indicated for use in such applications do so entirely at their own risk and agree to fully indemnify Vishay for any damages arising or resulting from such use or sale. Please contact authorized Vishay personnel to obtain written terms and conditions regarding products designed for such applications.

Product names and markings noted herein may be trademarks of their respective owners.